

S=1:500
野崎二丁目

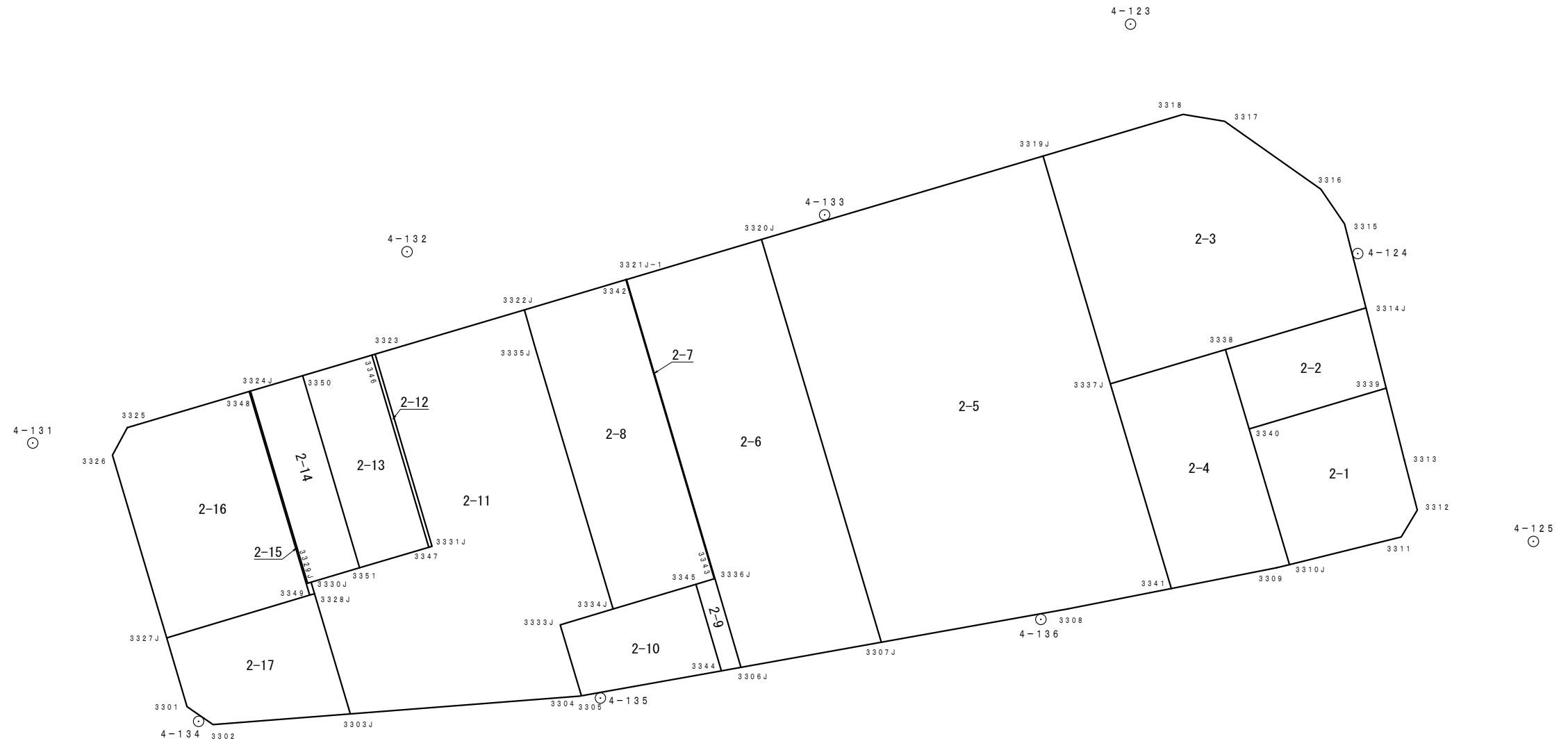

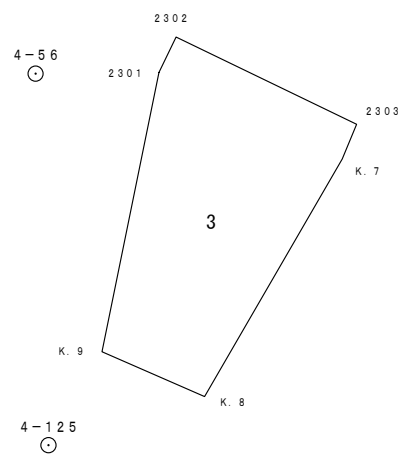

S = 1 : 500
野崎二丁目



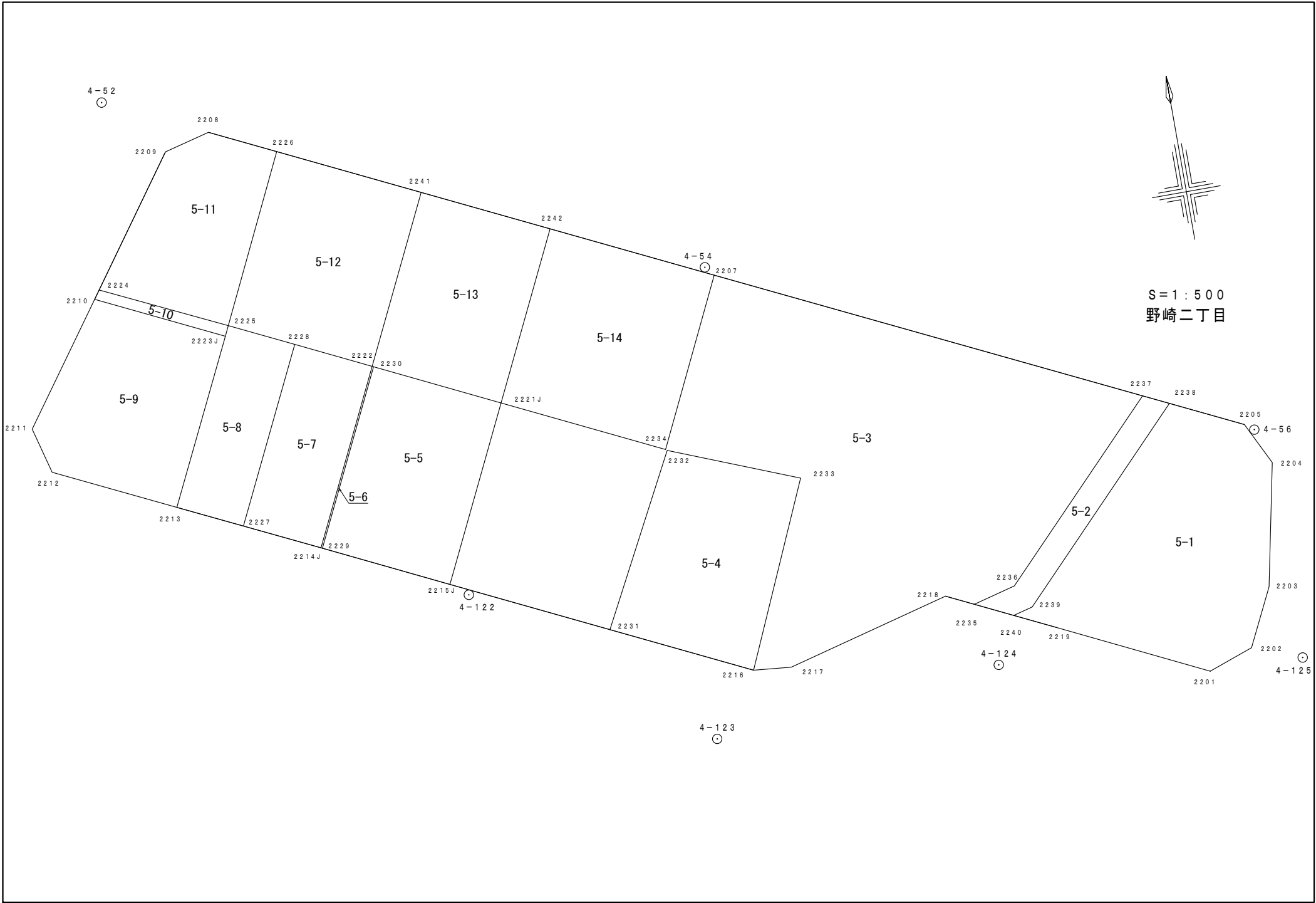

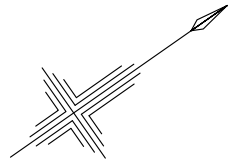

S=1:500
野崎二丁目

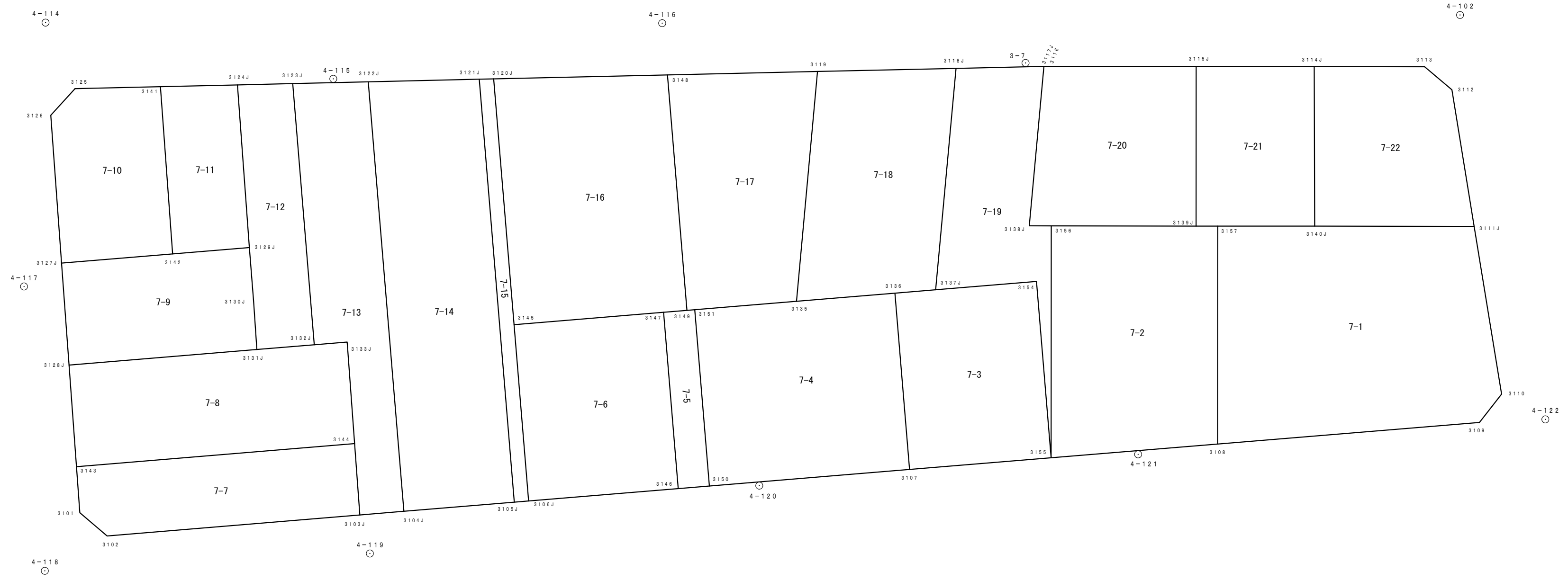

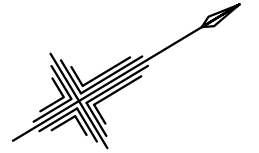

4-120
⊙

S = 1 : 500
野崎二丁目

4-118
⊙

4-119
⊙

4-129
⊙ 3401

3-11
⊙

4-130
⊙

4-131
⊙

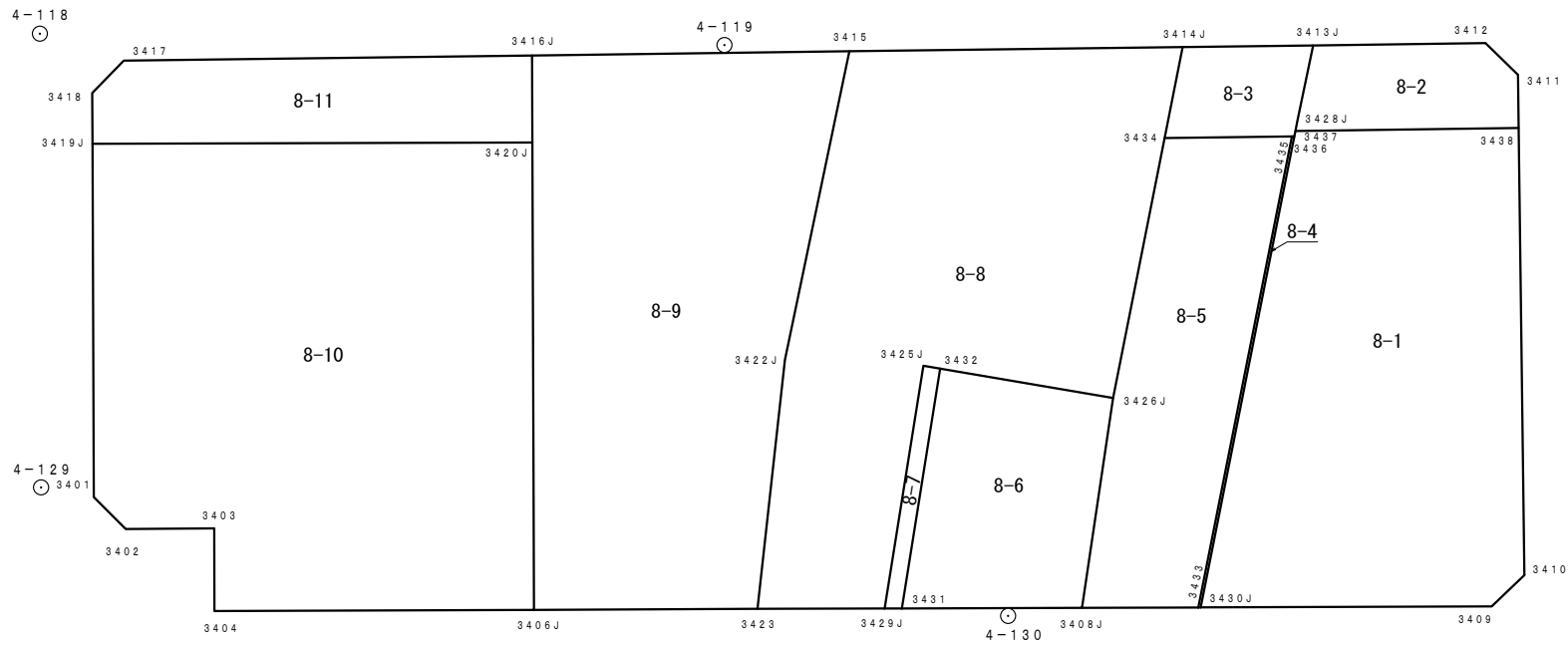

4-127
⊙

4-129
⊙

3402

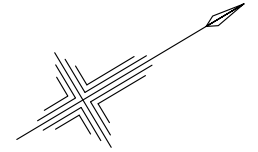

S = 1 : 500
野崎二丁目

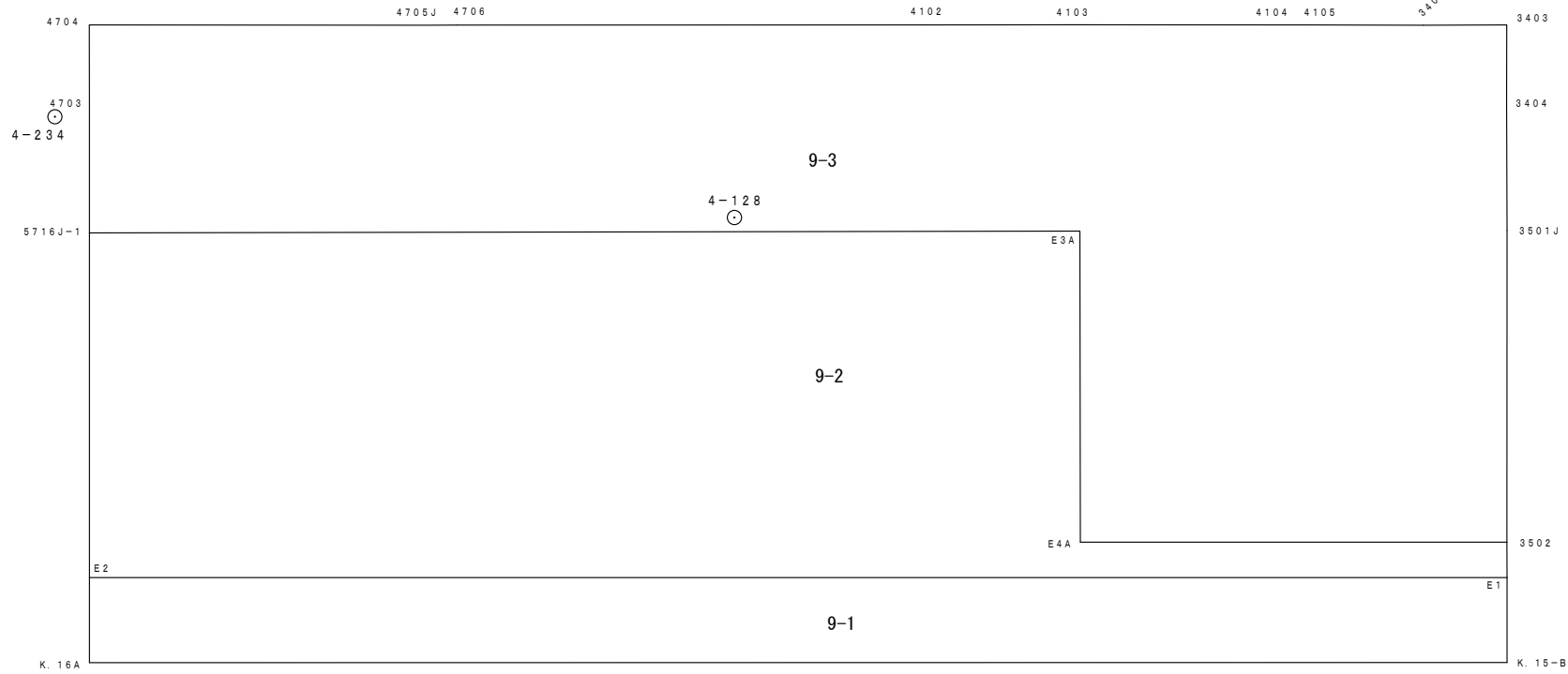

4704

4705J 4706

4102

4103

4104 4105

3403

4703

4-234

9-3

4-128

3404

3501J

9-2

E3A

3502

E4A

E2

E1

9-1

K. 16A

K. 15-B

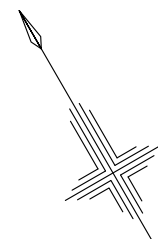

S = 1 : 500
野崎二丁目

4-114
⊙

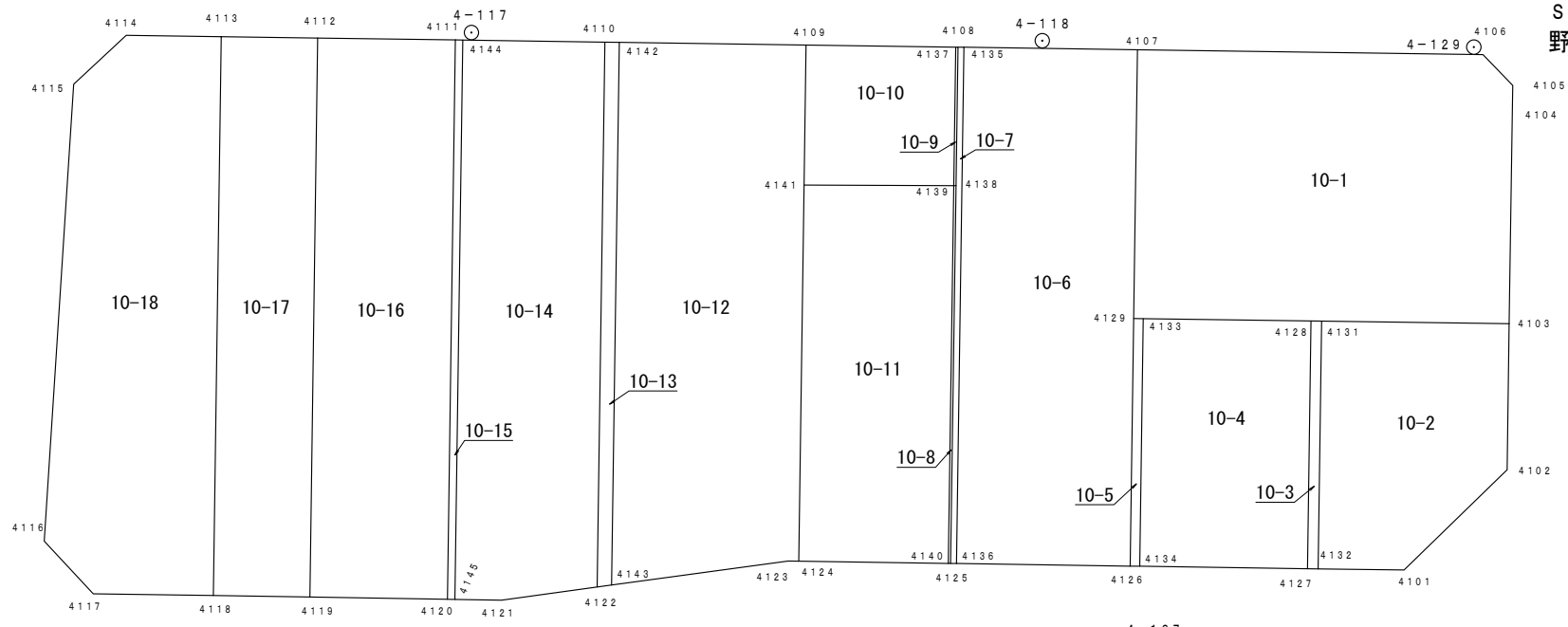

4-113
⊙

4-126
⊙

4-127
⊙

4-128
⊙

4-106
⊙

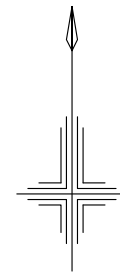

S = 1 : 500
野崎二丁目

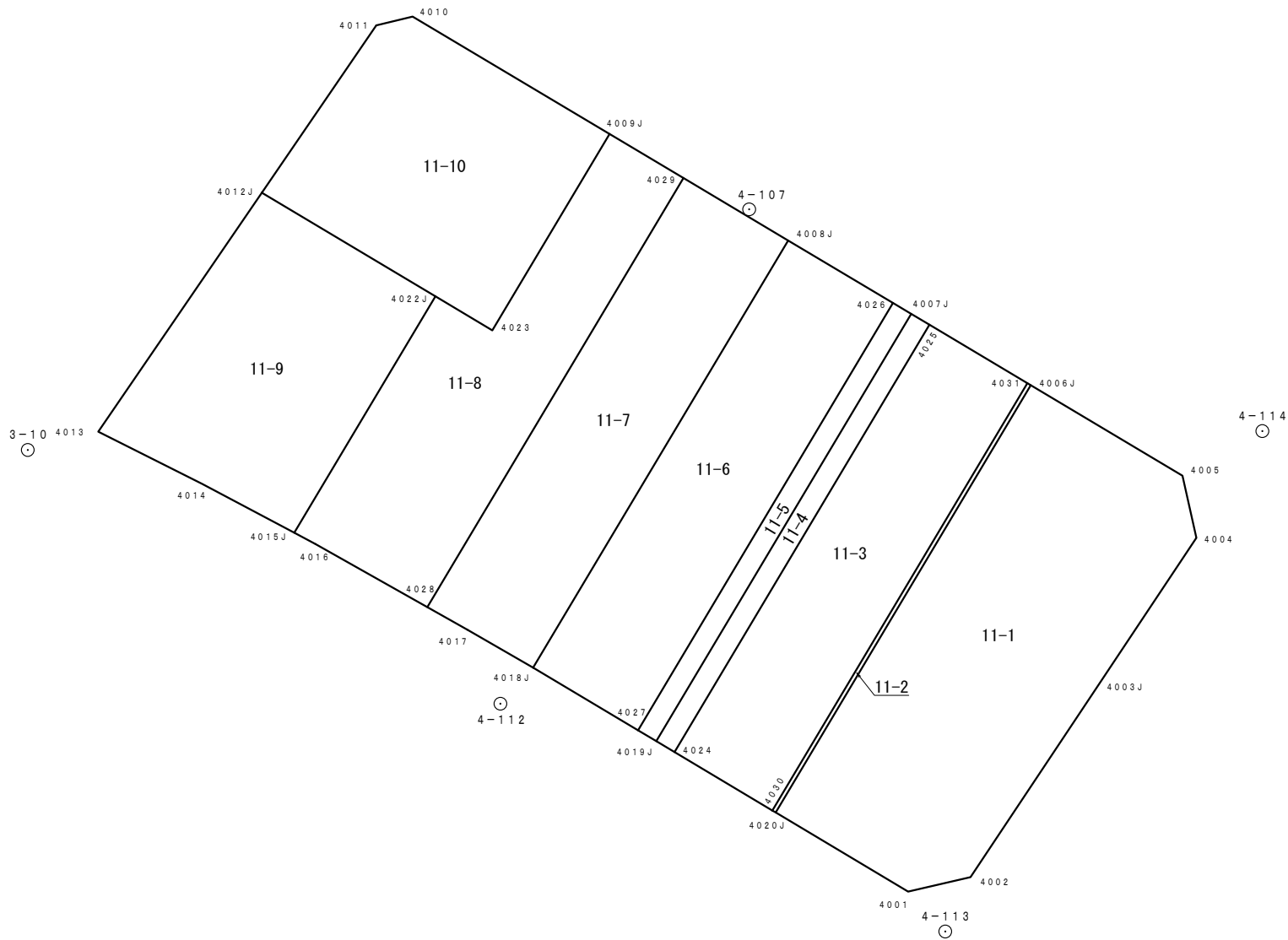

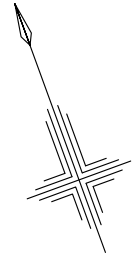

S = 1 : 500
野崎二丁目

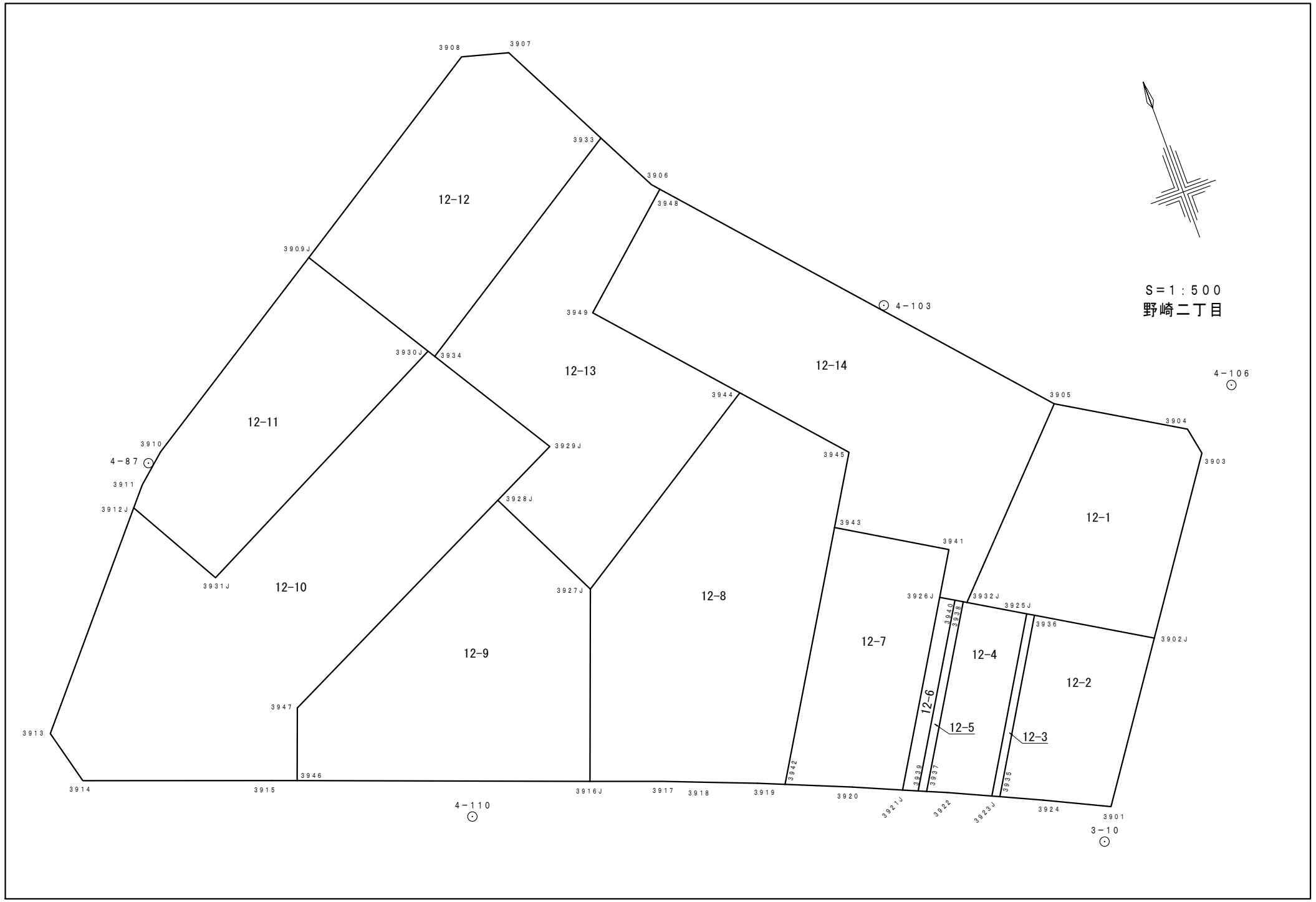

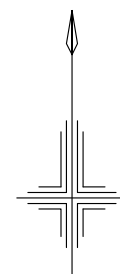

S = 1 : 500
野崎二丁目

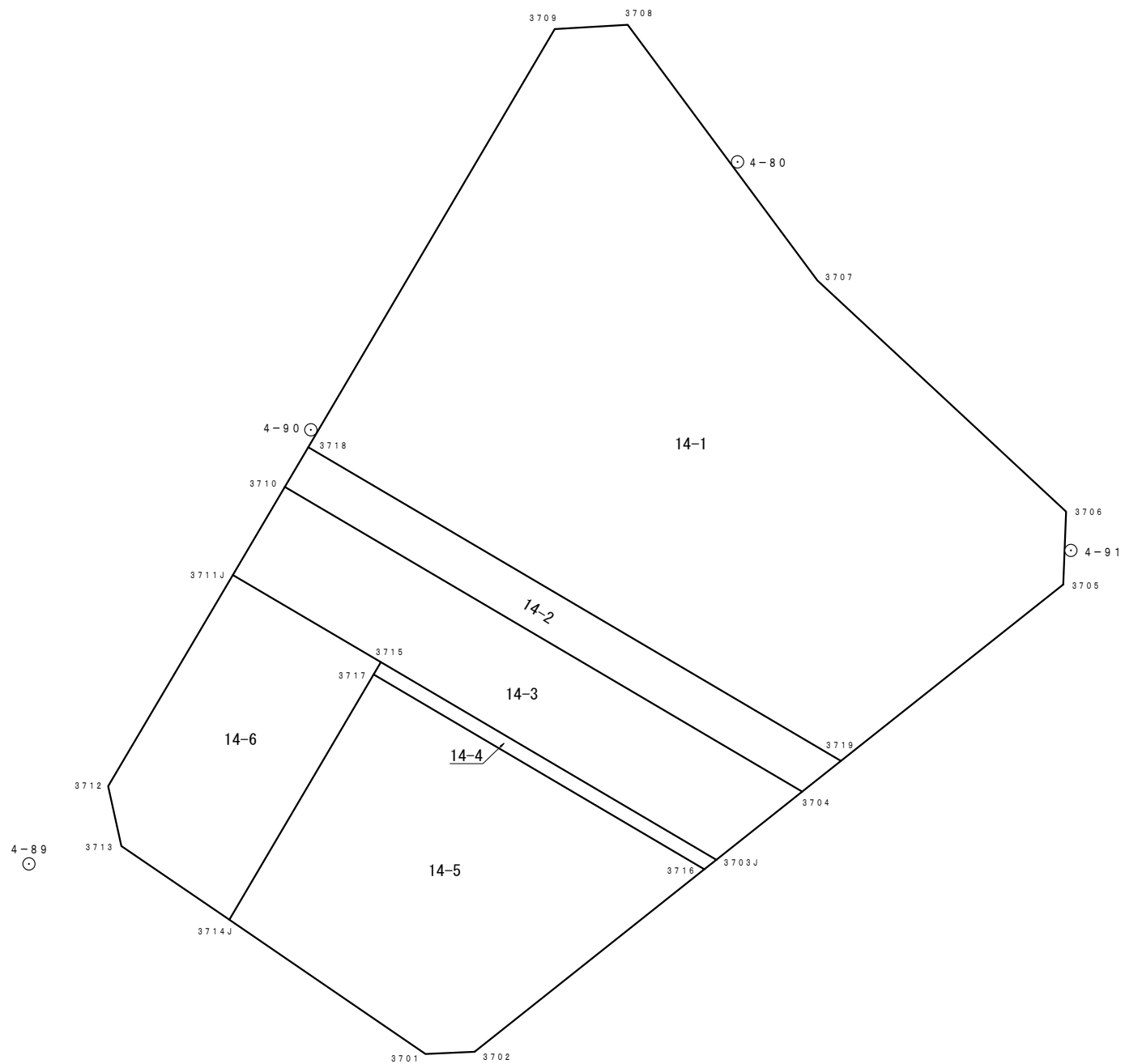

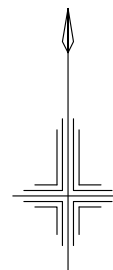

S = 1 : 500
野崎二丁目

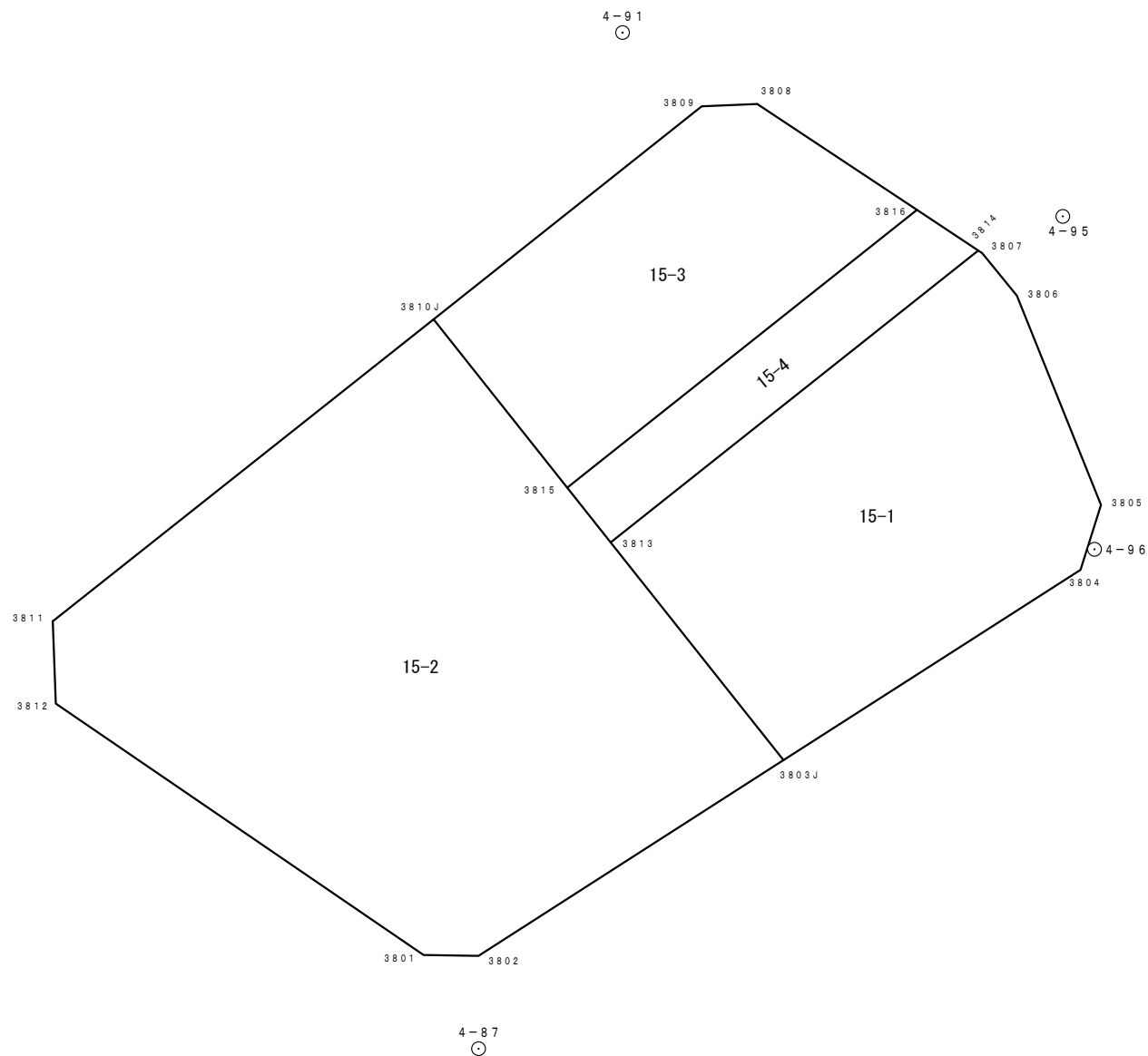

4-93

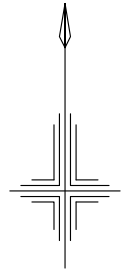

S = 1 : 500
野崎二丁目

4-267

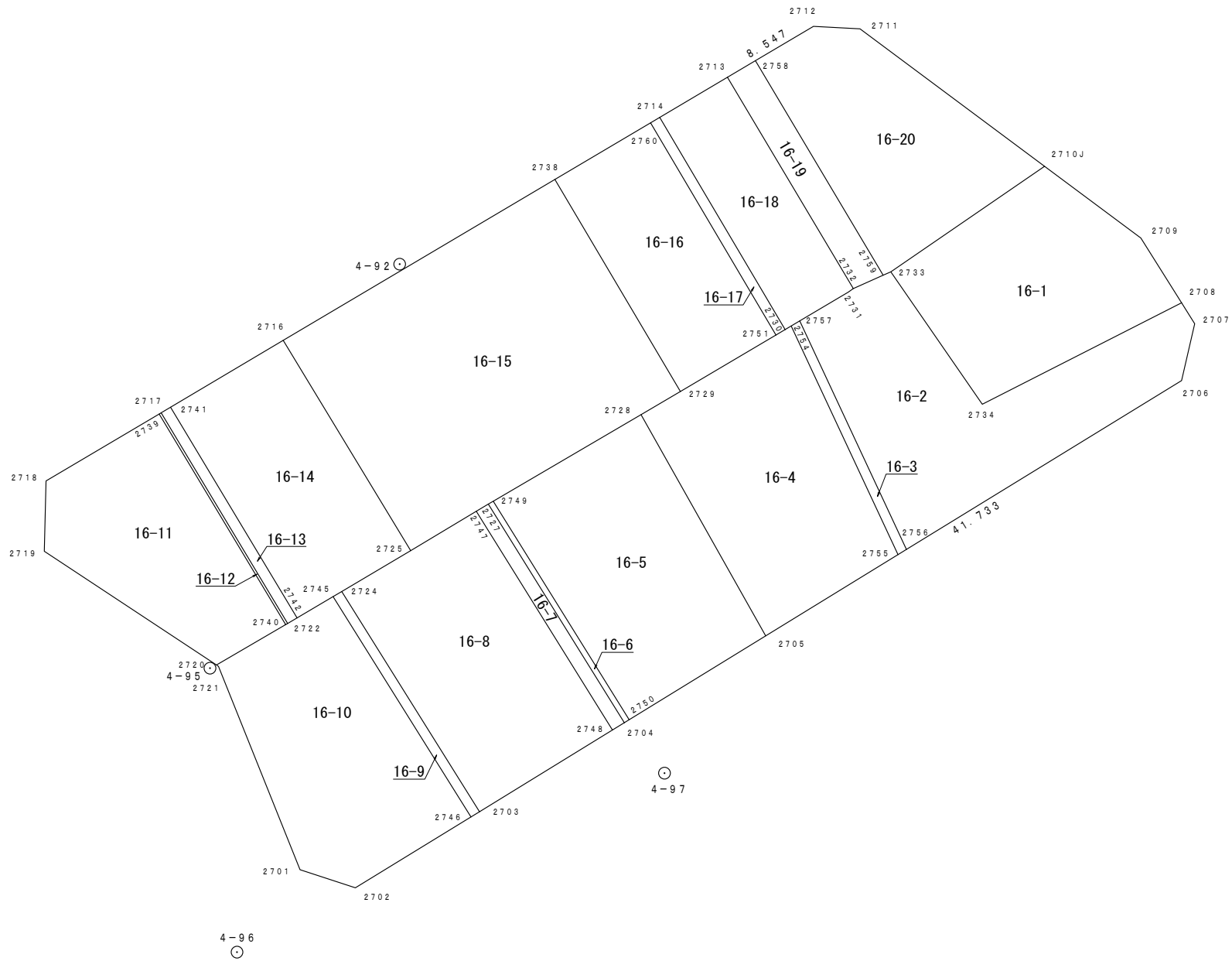

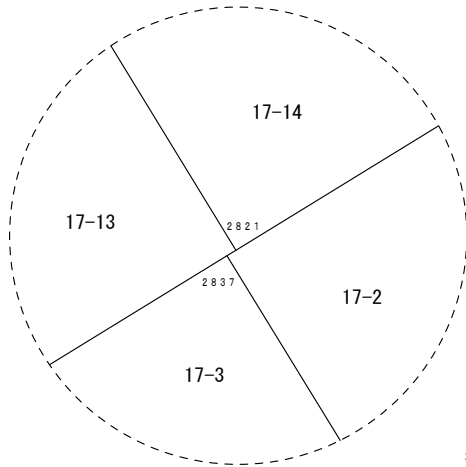

拡大図 S = 1 : 25

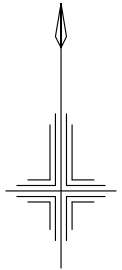

S = 1 : 500
野崎二丁目

4-96
⊙

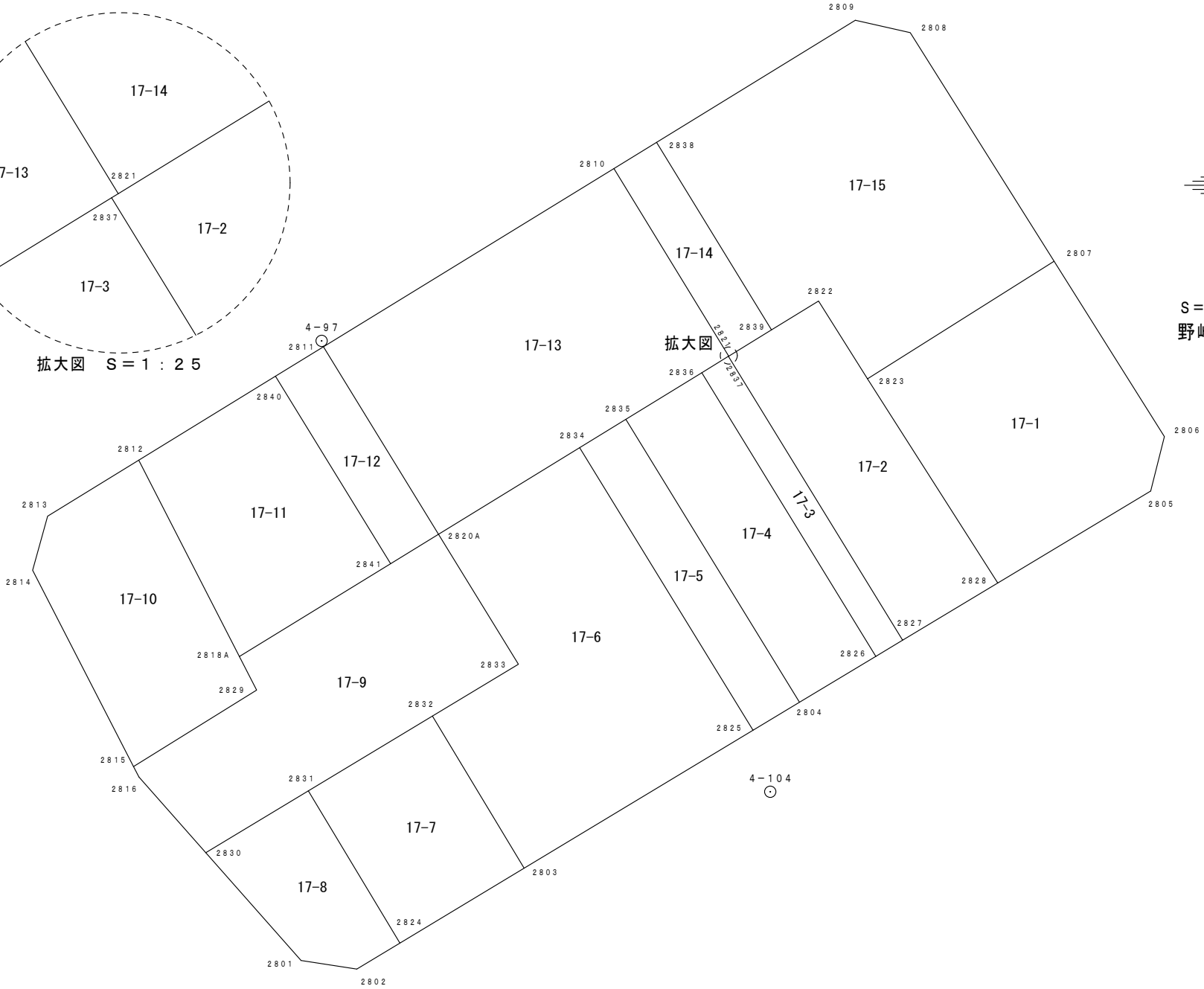

拡大図

4-268
⊙

4-104
⊙

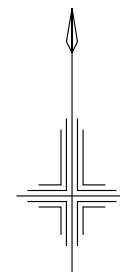
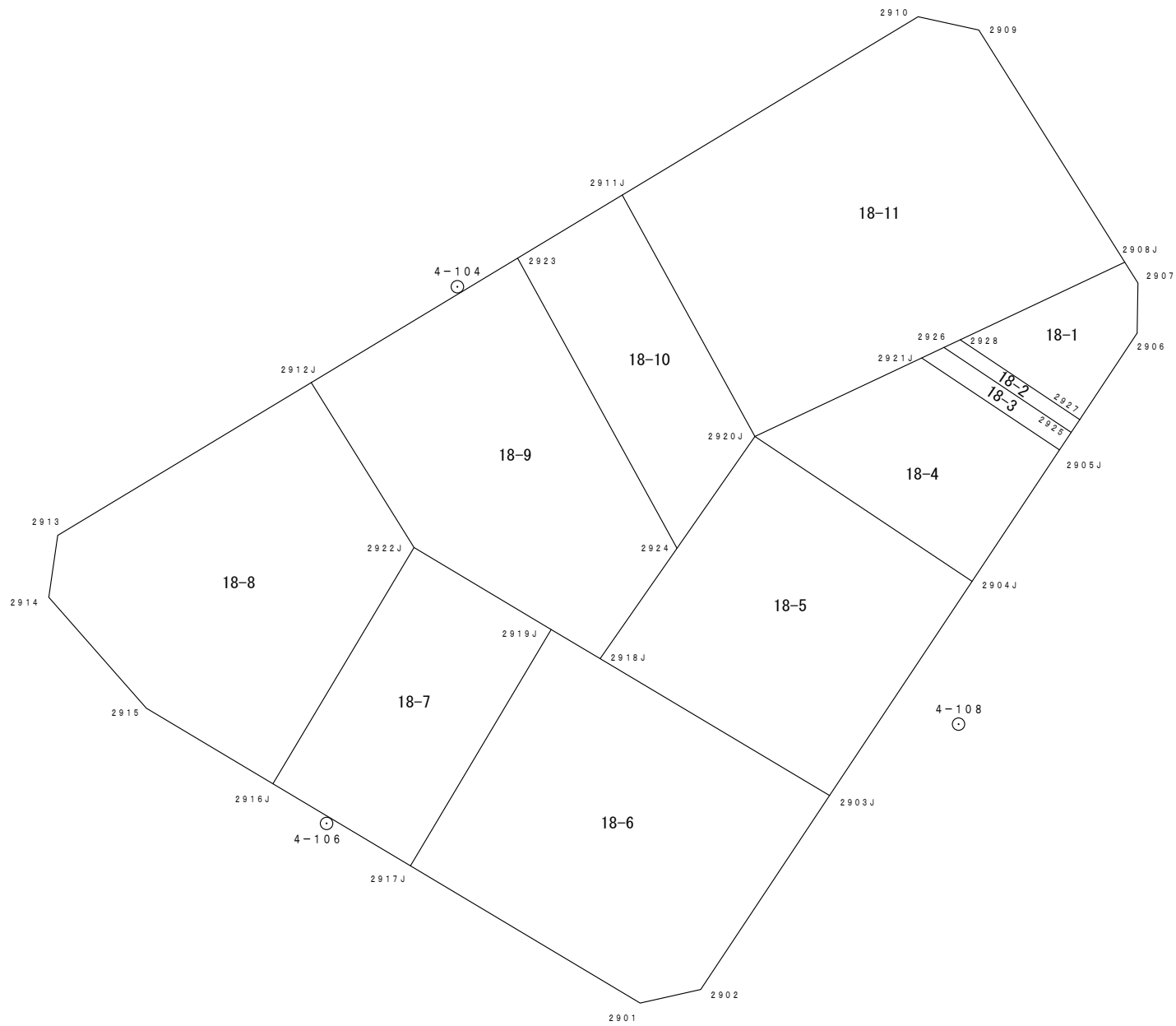

S = 1 : 500
野崎二丁目

4-109

4-108

4-106

4-103

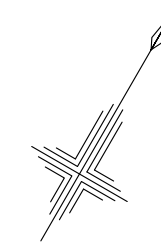

S = 1 : 500
野崎二丁目

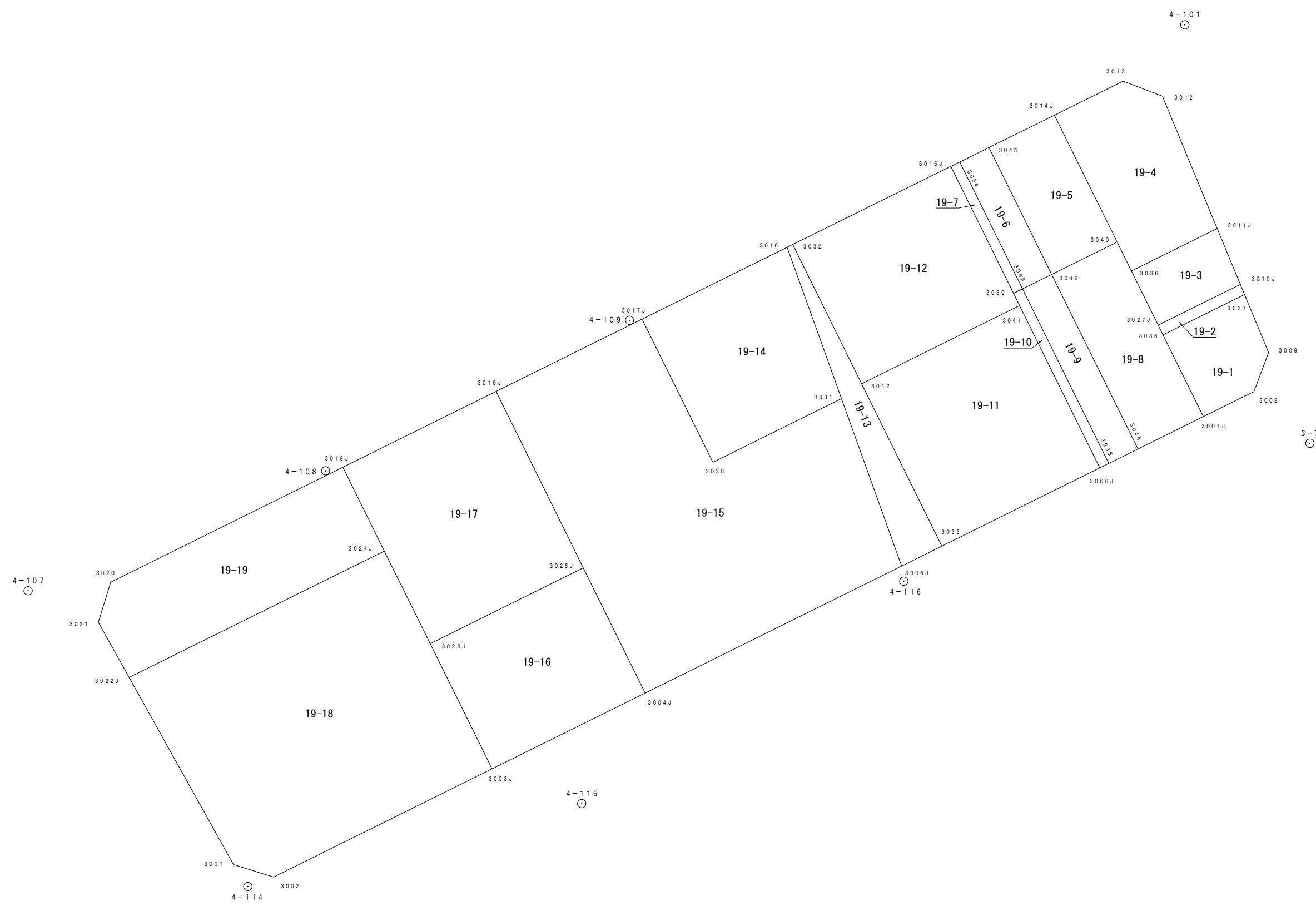

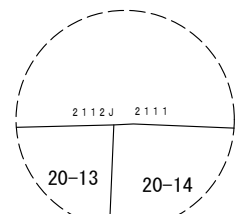

拡大図 S = 1 : 5 0

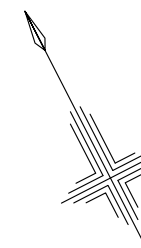

S = 1 : 5 0 野崎二丁目

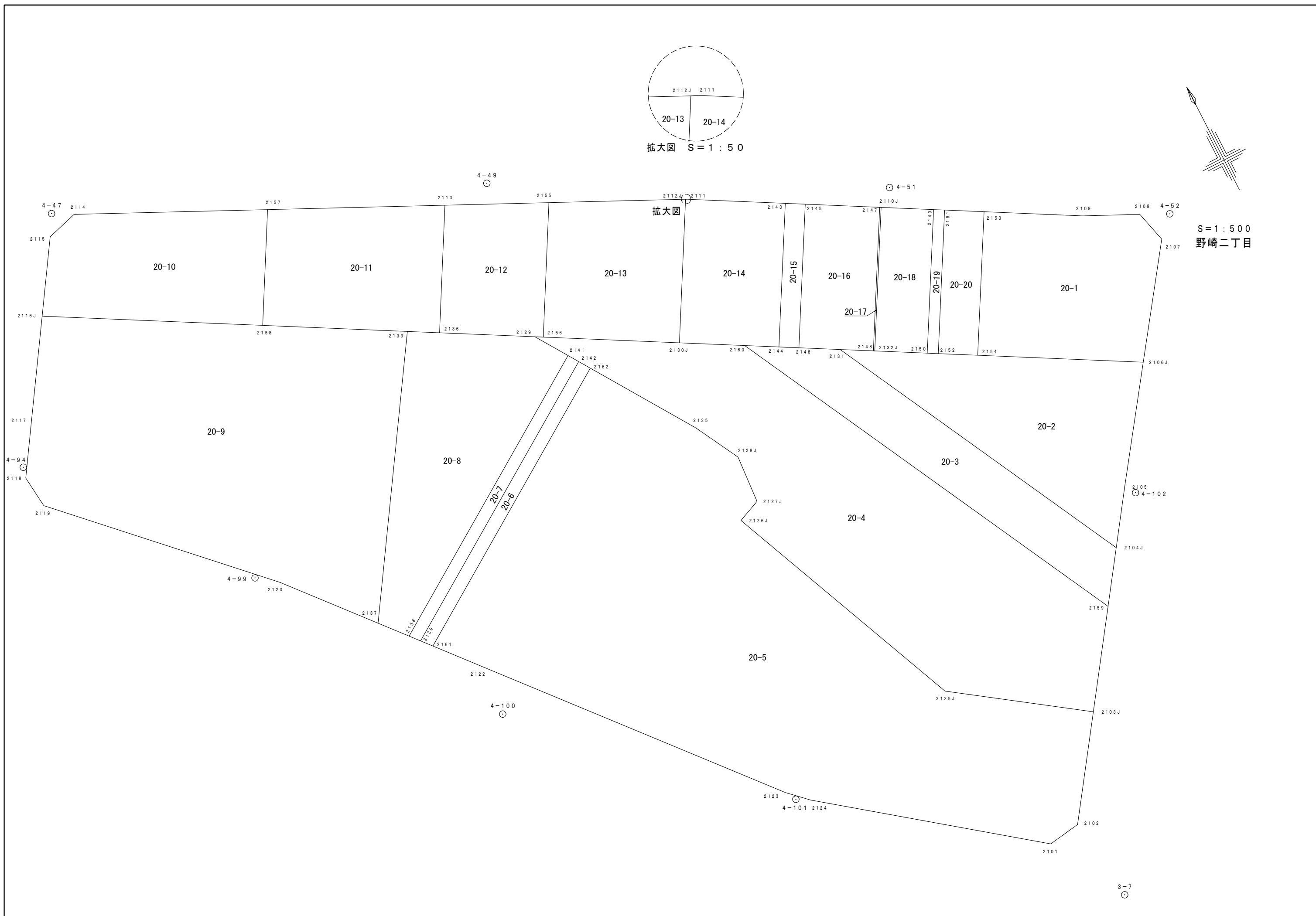



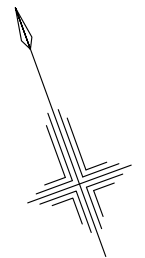
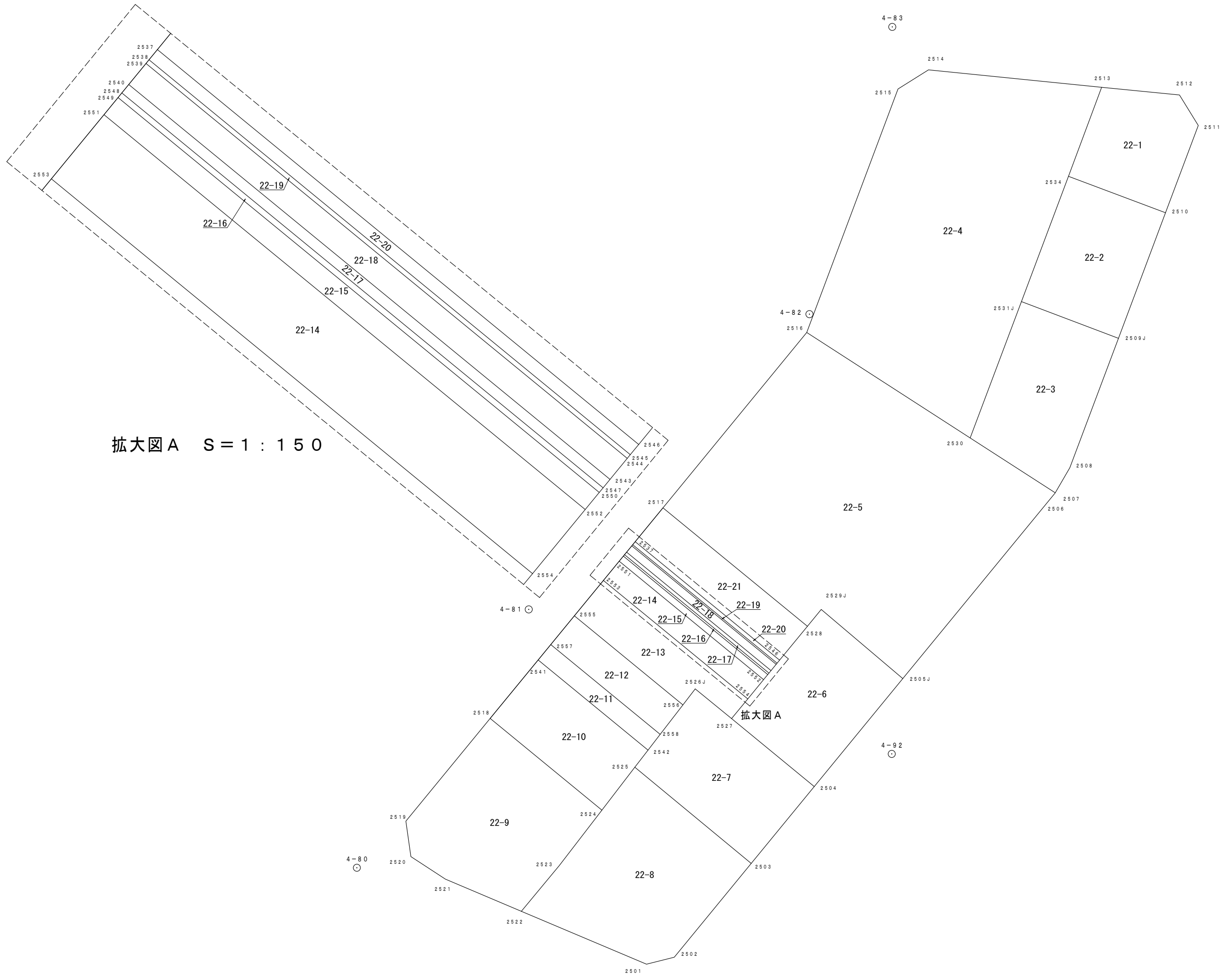

S = 1 : 500
野崎二丁目

拡大図 A S = 1 : 150

拡大図 A

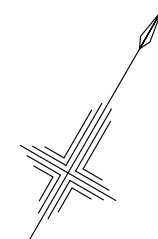

S = 1 : 500
野崎二丁目

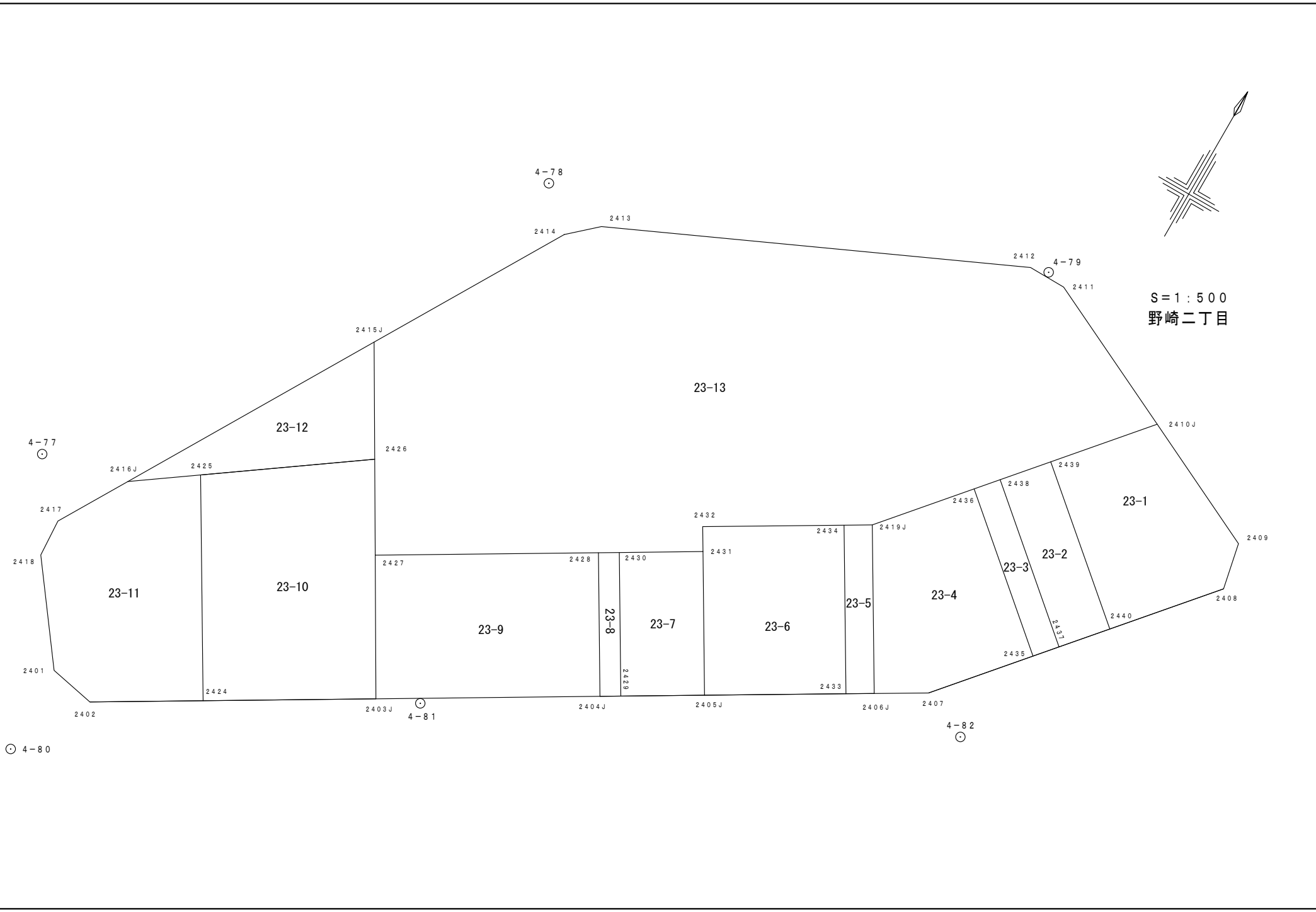

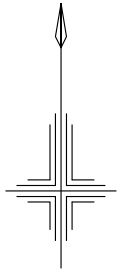

S = 1 : 500
野崎二丁目

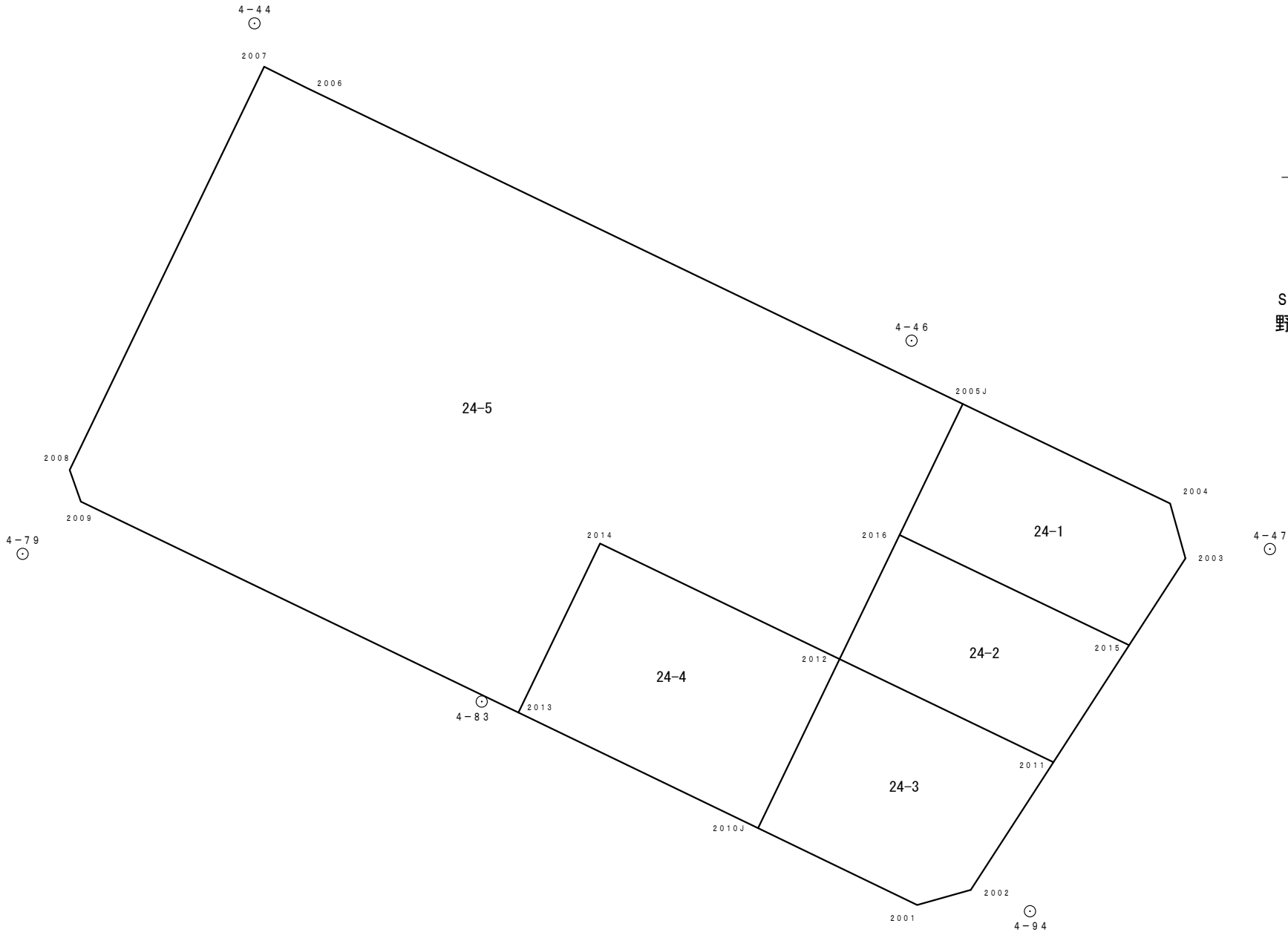

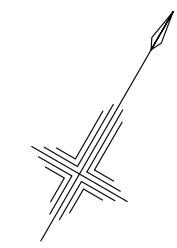

S = 1 : 500
野崎二丁目

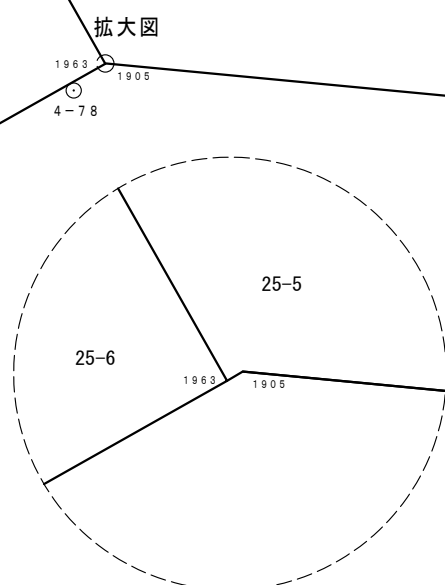
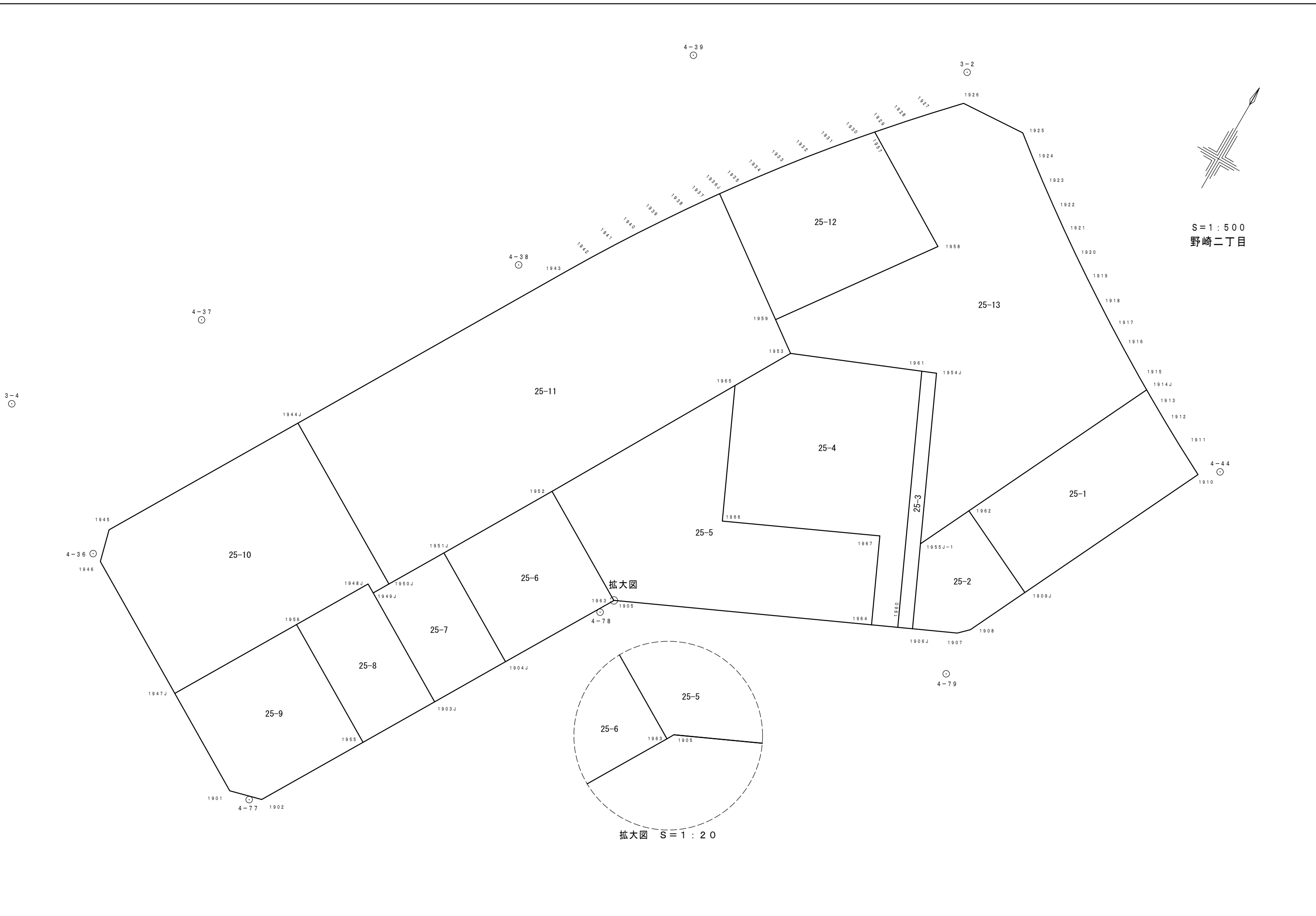

拡大図 S = 1 : 20

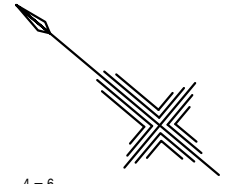

4-6

S = 1 : 500
野崎二丁目

4-1

3-1

4-40

4-42

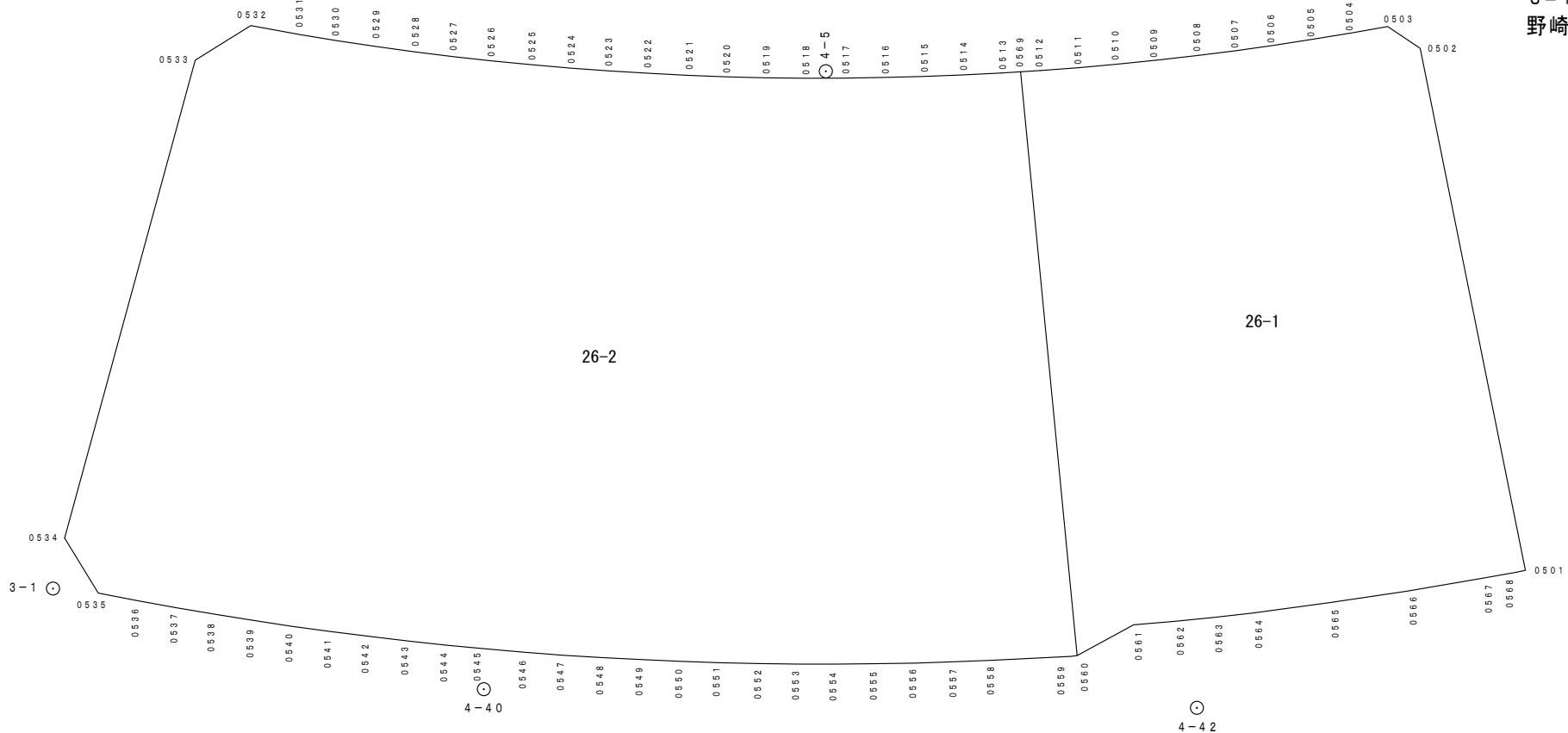

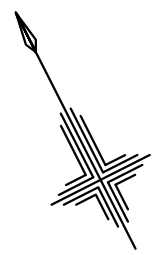

S=1:500
野崎二丁目

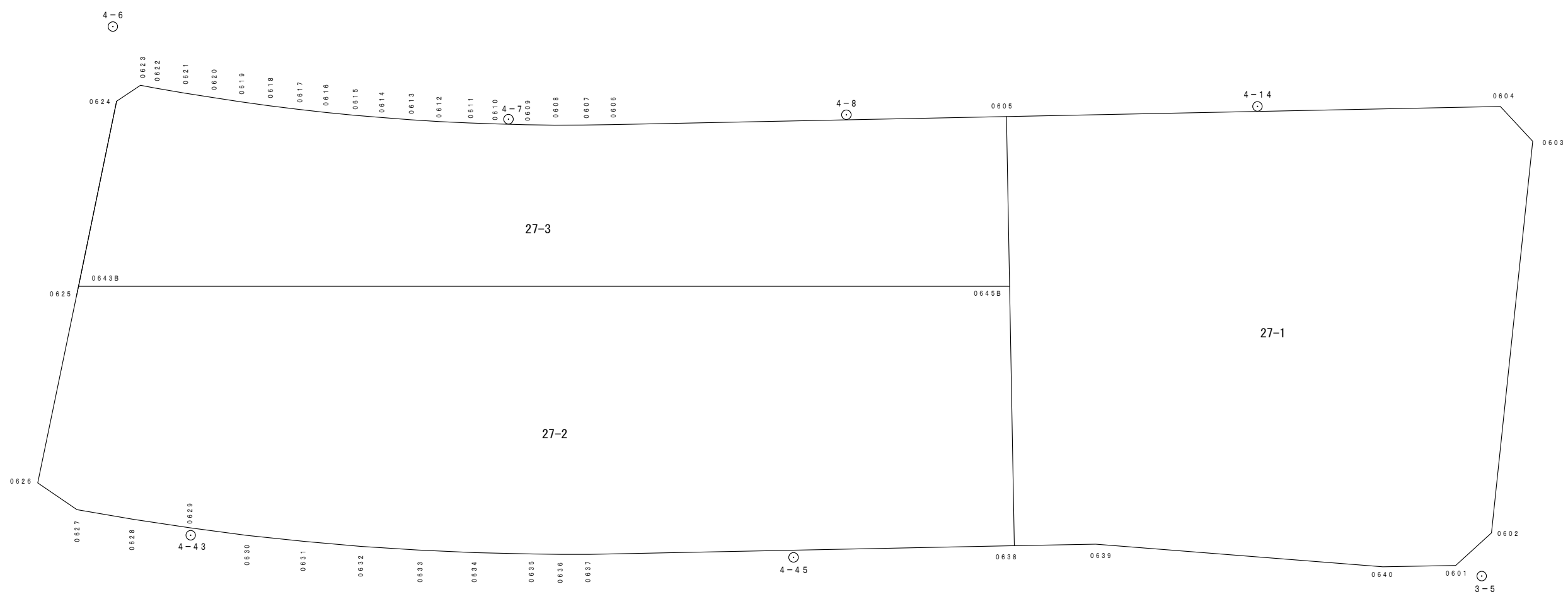

⊙
4-9

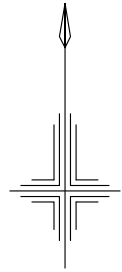

S=1:500
野崎二丁目

0207 0206

0205

0208

0204

⊙
4-11

28

⊙
4-8

0209

0203

0211J

⊙
4-14

0202

0201

⊙
4-15

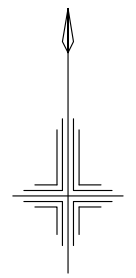
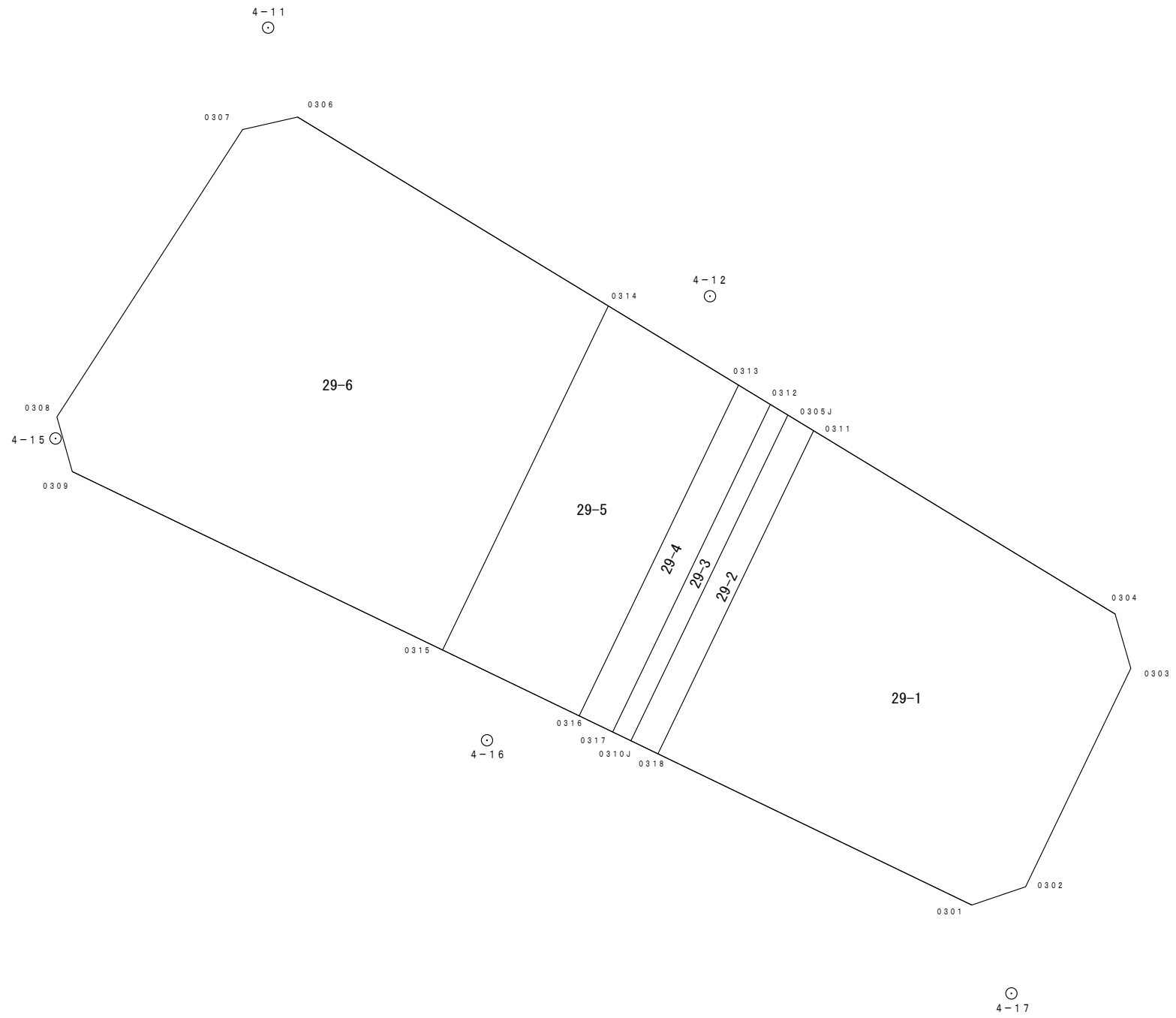

S = 1 : 500
野崎二丁目

4-11
⊙

0307 0306

4-12
⊙

0314

29-6

0313

0308

4-15
⊙

0312

0309

0305J

29-5

0311

29-4

4-13
⊙

29-3

0304

29-2

29-1

0303

0315

4-16
⊙

0316

0317

0310J

0318

0301

4-17
⊙

0302



S = 1 : 500
野崎二丁目

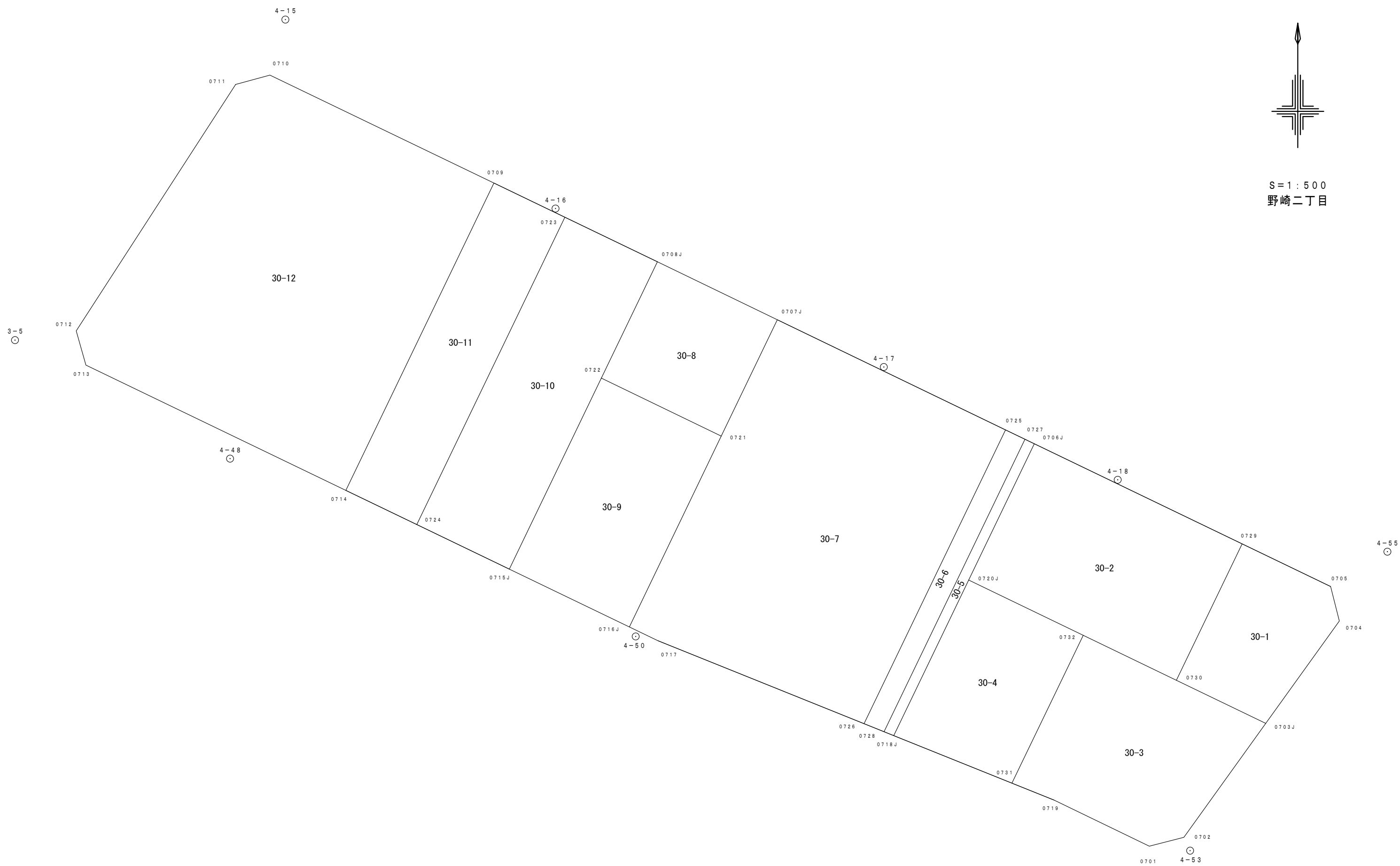

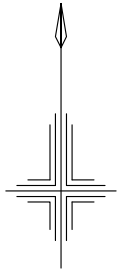
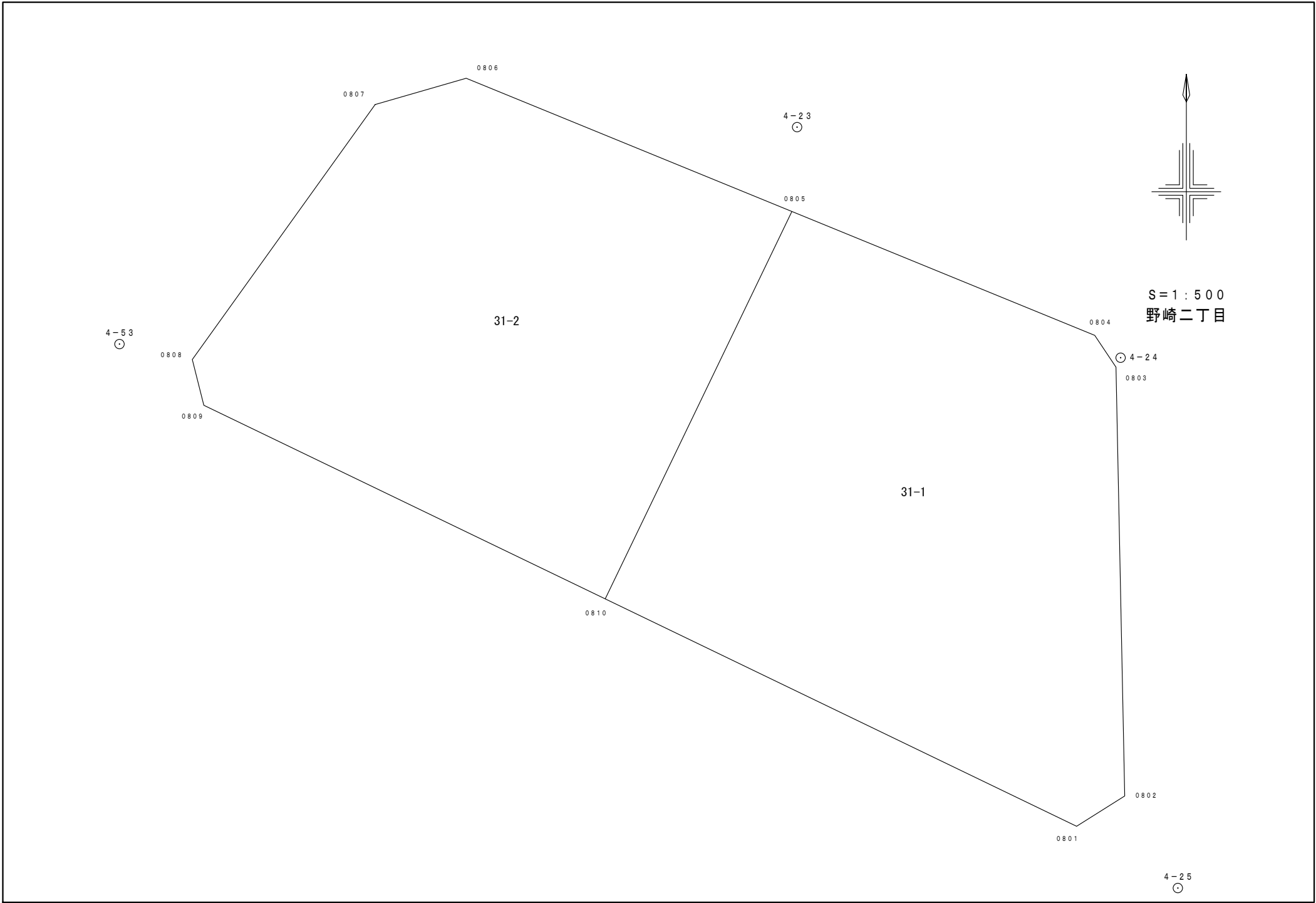

S=1:500
野崎二丁目

4-53
⊙

4-23
⊙

4-24
⊙

4-25
⊙

0806

0807

0805

0804

0808

0803

0809

0810

0802

31-1

31-2

0801

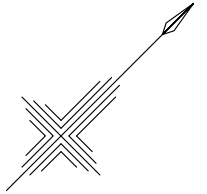

S = 1 : 500
野崎二丁目

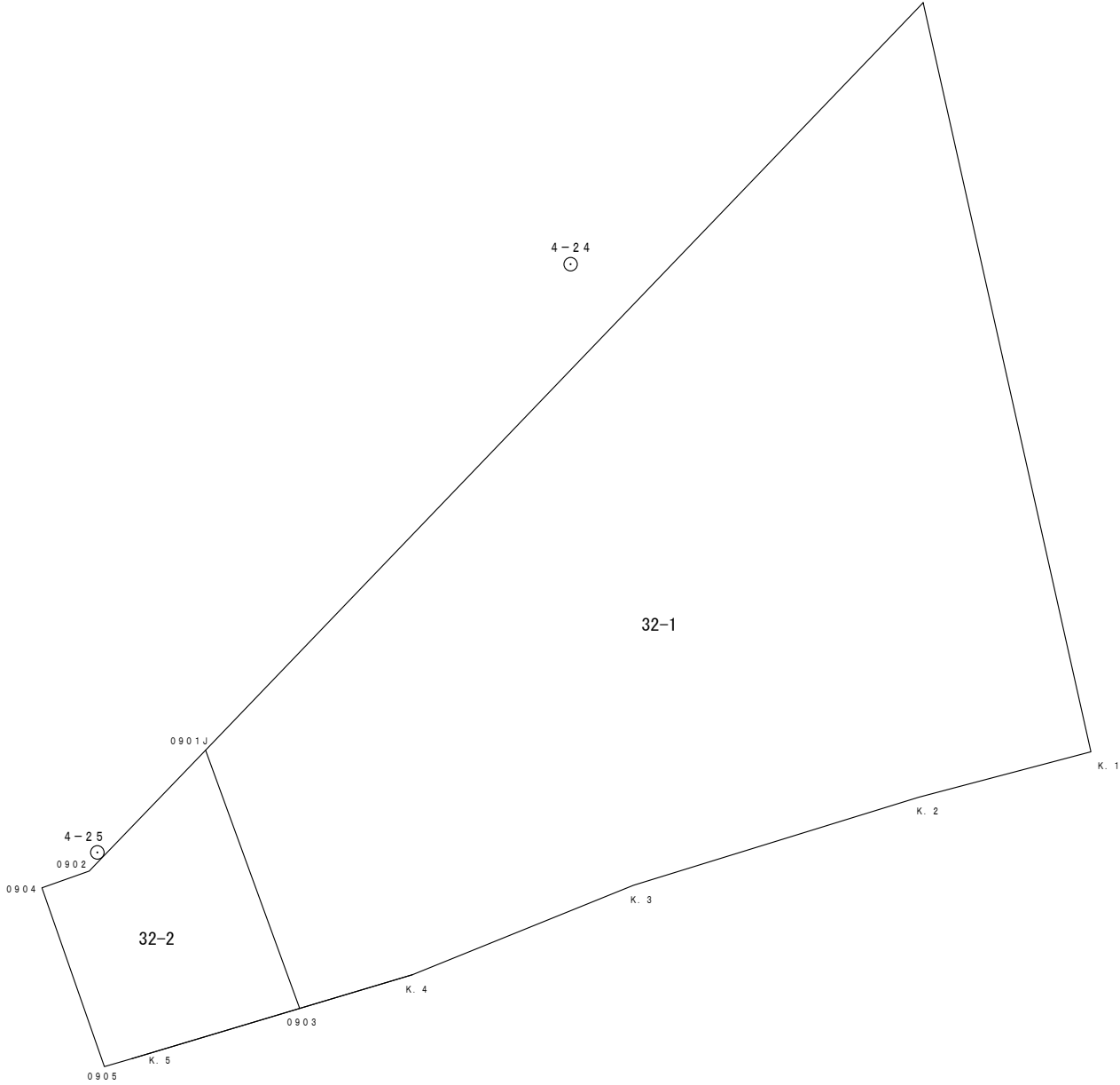

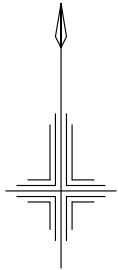

S = 1 : 500
野崎二丁目

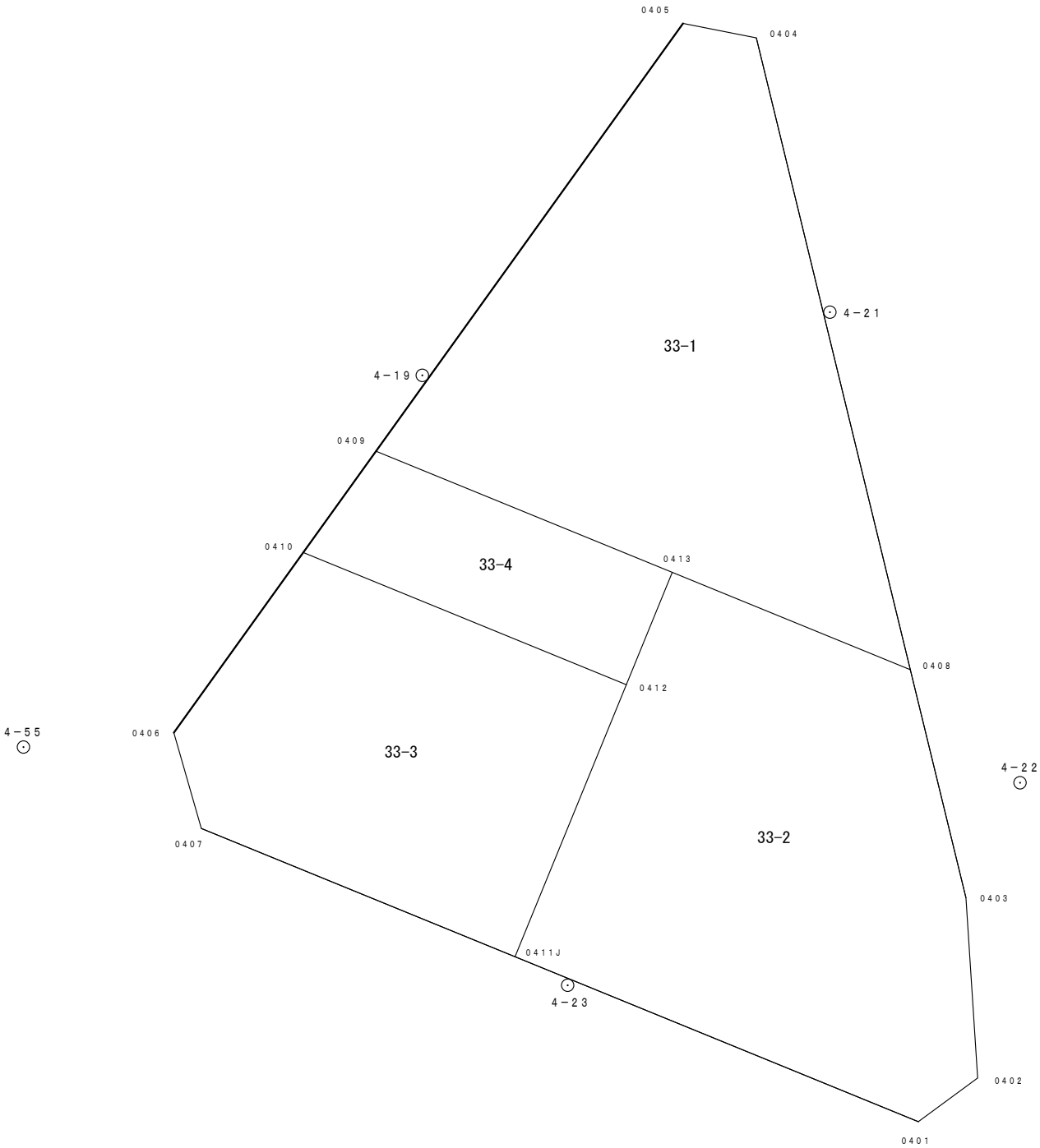

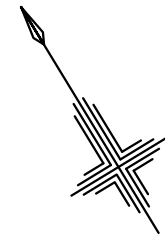

S=1:500
野崎二丁目

